

Input Impedance TD

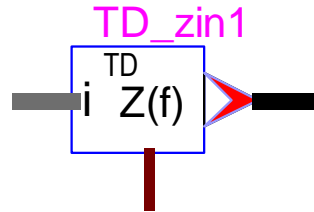

Input Impedance TD	1
1 Description	1
2 Parameters	1
3 Rules	3
4 Load-Flow model	3
5 Steady-state model	3
6 Frequency Scan model	3
7 Application example	4
7.1 Grid side scan	4
7.2 Converter side scan	6
7.3 Combined scan	8
7.4 Time-domain verification	8

Henry Gras, Ulas Karaagac, Jean Mahseredjian, 2/24/2020 2:34 PM

1 Description

This device is used to calculate the input impedance seen between two nodes using time-domain scanning. To find the impedance between a node and the ground, the user can connect the bottom pin to the ground.

The input impedance is calculated for the range of frequencies specified in the device mask.

The frequency scan is performed with time-domain simulations. All circuit devices are modelled using their complete time-domain representations.

This device can be used to perform sub-synchronous control interaction analysis of converter-based devices like wind parks, solar farms or HVDC.

The impedance angle and magnitude are determined using Discrete Fourier Transform. Because several frequencies can be found in the circuit during the scan, the DFT window is automatically adjusted to filter all frequencies except the one of the perturbed frequency. The window must be a multiple of all frequency periods.

2 Parameters

- step (Δf):** Frequency step.
- f_{\min}** Minimum frequency. First value of the frequency sweep.
- f_{\max}** Maximum frequency. Last value of the frequency sweep.
- I_{mag}** Magnitude of the current injected during the frequency scan.

- **Time-step** Numerical integration time-step in time-domain simulations. Must be at least 10 times smaller than the period of the highest frequency. If it is not the case, the time-step is changed accordingly, and a message is displayed in the console.
- **Maximum number of periods**
 - Maximum number of periods to wait before selecting the next frequency if the impedance cannot be identified by the DFT algorithm. This is the case when the magnitude and angle measurement variations do not fall within the specified tolerance. If the **Maximum number of periods** is reached, the impedance point is not recorded.
 - The length of the DFT period is automatically calculated to be the least common multiple of the existing frequency periods. Therefore, the smaller Δf is, the longer each frequency-scan simulation is. The existing frequencies are:
 1. the frequency-scan perturbation frequency
 2. the frequencies specified in the **List of frequencies**.
 - The total length of each simulation will be the **Initialization time** plus the **Maximum number of periods**.
- **Tolerance** The impedance identification is validated when the magnitude and angle variations calculated by the DFT are lower than this **Tolerance**. A simplified version of the scheme detecting the magnitude convergence is shown Figure 1. The magnitude is averaged over a cycle. If the magnitude derivative is lower than the **Tolerance** specified for at least 1 cycle, there is convergence. The same scheme applies to the impedance angle convergence. Both magnitude and angle convergence must be achieved.

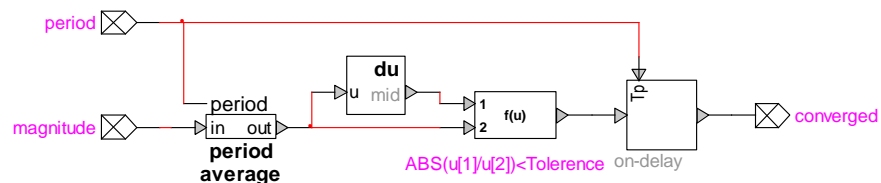

Figure 1 Impedance magnitude convergence detection

- **Initialization time**
 - Initialization time required by the scanned network. This is the time required to reach steady-state conditions. The scan starts when steady-state is reached and the current injections are started at this point. For example, for a wind-park, it is typically 0.5 s.
- **Simulate initialization once**
 - If this option is checked, the initialization is performed only once, and all frequency scan simulations are started from the end of initialization interval. This option helps to save computing time. The Netlist is also generated only once. It is recommended to always check this option, except if the design contains user-defined DLLs which have not been built to support the Statistical Simulation options (usage of DLL_SAVE_ME and DLL_LOAD_ME requests) or if the scan is started by scripts.
 - When this opt box is not checked, the netlist is generated at each run.
- **Save all simulation waveforms**
 - When this option is checked, all time-domain waveforms for all scopes and all simulations are saved on disk. It may significantly increase the storage requirements of your study.
- **Averaging period**
 - Averaging period for impedance calculation. An average period equal to the scanning frequency period is applied by default. If the value of this field is larger than 0, the maximum between the default averaging period and the one entered by the user is selected.
- **Add current measurement input**
 - If this option is checked, an input bundle is added to this device for allowing to input the current measurements for the evaluated impedance. An example is presented below.

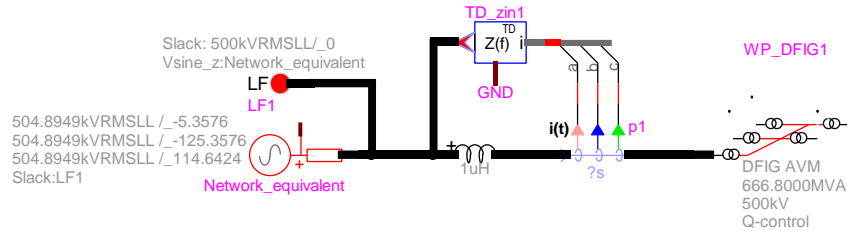

Figure 2 Example of usage of 'Add current measurement input' option

□ List of frequencies

- Enter the list of frequencies (comma separated list) for existing active sources in the circuit during the frequency scan. This list is used to filter out the frequencies other than the one the system is scanned for.

□ Start the scan

- Check this option to start the time-domain frequency scan. The simulations will start after pressing the OK button. Each “Input Impedance TD” device operates independently and performs its own set of operations. During normal simulations (Run button in Simulate ribbon or other functions uses externally) this device becomes inactive.

□ Plot scan results

- Once the time-domain frequency scan is completed, check this option to automatically display the resistances and reactances as functions of frequency and as resulting from the scan.
- The result file is found in: *designName*_pj/TD frequency sweep/*TDdeviceName*.txt where *designName* is the name of the design where the scan is performed and *TDdeviceName* is the name of this device.
- All Input Impedance (Time-Domain) devices must be given different names.

3 Rules

The computation is performed by injecting a current (for each frequency) at a magnitude defined by the user and in the direction pointed by the device symbol red arrow. The voltages and currents between the positive node (injection point with the red arrow) and negative node (bottom pin or ground) are measured and the positive sequence components (voltages, currents, impedances) are calculated. The window used for the Discrete Fourier Transform (DFT) is the inverse of the greater common multiple between the scanning frequency and the **List of frequencies** input. For example, if the scan is done for 30Hz and a 60Hz frequency is present in the scanned network, the window will be 1/30 s.

The impedance is found by dividing the positive sequence voltage by injected positive sequence current. Because of the harmonics and noises which could be present in the voltage and current measurements, the calculated impedance is averaged over **Averaging period**.

When the device is not performing its operations, it is disabled, and the injected current is zero.

4 Load-Flow model

This device becomes an open-circuit in the Load-Flow solution.

5 Steady-state model

This device becomes an open-circuit in the Steady-State solution.

6 Frequency Scan model

This device becomes an open-circuit in the Frequency Scan solution.

In this case the scan is performed in frequency domain using the “Input Impedance” device of EMTP. It is important to notice that the WP must be excluded from this scan and the network is arranged for the studied contingency condition by excluding the top part which becomes isolated by line breakers due to a fault.

For SSCI, the frequency-scan is typically performed between 5Hz and 60Hz with steps of 1 Hz (see Figure 5). To simplify the combination of grid and converter scans, it is convenient to use the same frequency steps in both scans.

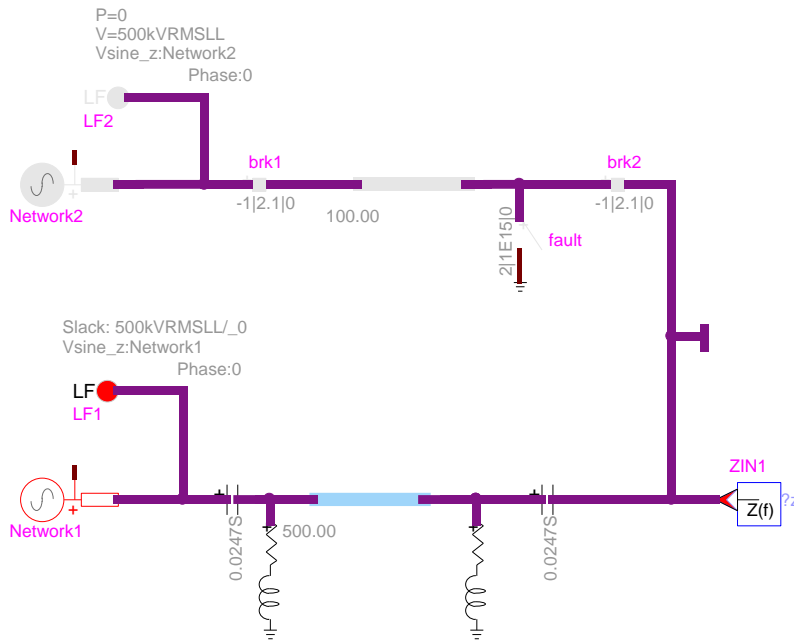

Figure 4 Grid (Network) side scan

Find Load-Flow solution

- Start from previous Load-Flow solution
- Find Steady-state solution and start from steady-state
- Start Steady-state solution from Load-Flow solution

Find Time-domain solution

Frequency scan

- log scale
- Number of points per decade
- step (Δf) Hz
- f_{min} Hz
- f_{max} Hz
- Match source frequency

Figure 5 Grid side scan, Simulation Options

The scan is performed using the standard Run command from the Simulate ribbon. ScopeView can be used to find the resistance and reactance parts from the scanned impedance magnitude and phase. This is done entering the following in ScopeView for this case:

Selected Signals				
Signal	Description	Show	Page	
1	ZIN1_mag_zinmag*cos(ZIN1_ang_zinang*pi/180)	<input checked="" type="checkbox"/>	1	^
2	ZIN1_mag_zinmag*sin(ZIN1_ang_zinang*pi/180)	<input checked="" type="checkbox"/>	1	
3		<input type="checkbox"/>	0	v

The obtained waveforms are shown in Figure 6.

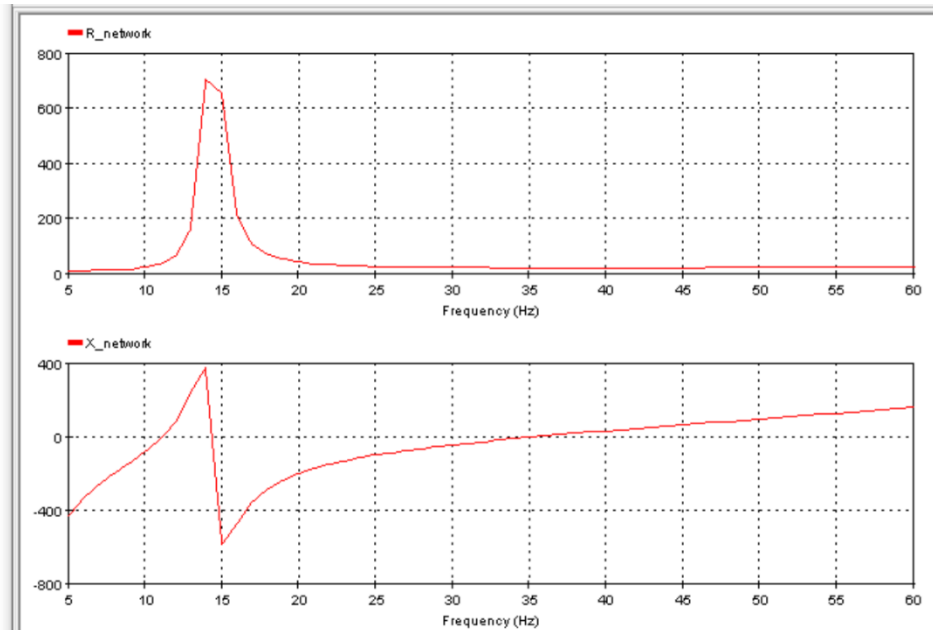



Figure 6 Grid side scan, R and X parts of impedance seen from ZIN1 in Figure 5

At this stage it is needed to save the above results into a text file. This is done using the ScopeView export button  and selecting a file (GridScan.txt)

7.2 Converter side scan

The second step is to obtain the WP frequency response at the WP connection point to its grid (see Figure 2). Because this device is nonlinear, the scan must be performed in time-domain using “Input Impedance TD” and near the operating conditions. In this example, the injected current can be set to 1 pu using the WP power and voltage:

$$I_{\text{injected}} = \frac{S_b * 1000}{\sqrt{3} * V_b} = \frac{667000}{\sqrt{3} * 500} \approx 770 \text{ A}$$

During nominal operation, the WP operates in grid-connected mode. Therefore, when the scan is being performed it must be connected to a grid. The best approach is to use a network equivalent as shown in Figure 2. The source impedance at 60 Hz can be found in the file GridScan.txt save above.

The device TD_zin1 in Figure 2 is connected between the injection node (arrow) and the ground. In this configuration, the scanned impedance is the one of the WP in parallel with the grid equivalent impedance. Therefore, only the current going into the WP should be measured to determine its impedance. It is recommended to adjust this current to about 1 pu. This might require one or two manual iterations to adjust the “Input Impedance TD” current. In this example, 1.2 kA is injected to obtain a current of 0.9 pu flowing into the WP. As explained in Figure 2, the “Add current measurement input” option must be checked to allow the measurement of WP current.

During the scan, it is recommended to use the same frequency step as in Figure 5. This will simplify the combined impedance calculation step. In this case the range specified in TD_zin1 is: 5Hz to 50Hz. If the WP converter is modeled using the DM version, the Time-step of TD_zin1 must be lower than 10 μ s, whereas if an average value model is used, the Time-step can be set up to 50 μ s.

During the scan, the converter-based device (WP in this case) must remain in a linear operation mode. If a protection trips, an on-load-tap changer changes tap or if a limit is reached, the scan will become invalid. Engineering judgement and visualisation of waveforms is required. One may potentially use the “Simulation stop” device from the Control library to detect abnormal conditions and avoid capturing the impedance at the given frequency. For example, in Figure 7, the “Simulation stop” device is placed at the outputs of the protection block. If a protection trips during a scan, the simulation will be stopped, and the impedance will not be captured. The results for this frequency will then be missing from the result file, which indicates that the scan was invalid.

If the “Save all simulation waveforms” in TD_zin1 is on, the missing frequency result cases can be easily visualised.

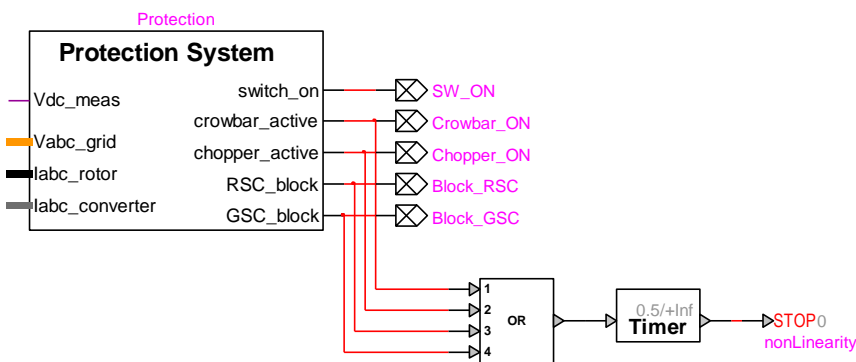

Figure 7 Detection of nonlinear condition: protection trip

After completing the design of Figure 2, the TD_zin1 function must be started using the checkbox “Start the scan” and clicking on the OK button. Once the scan is terminated, the user can reopen the TD_zin1 device, select “Plot scan results” and then push on the OK button. The results will appear in ScopeView as shown below.

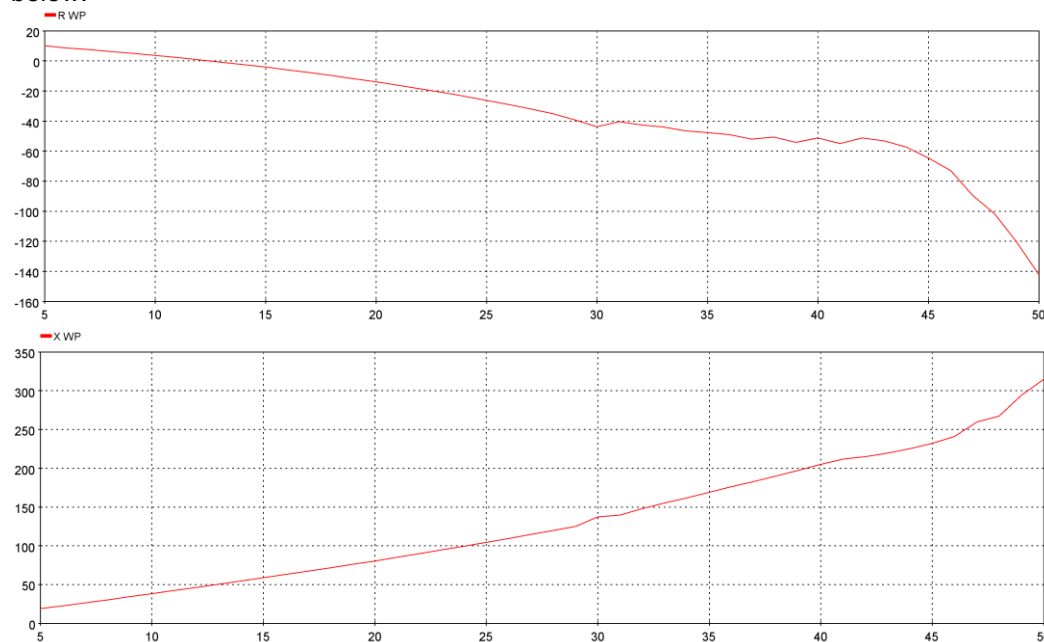



Figure 8 WP impedance scan using “Input Impedance TD”

Once again it is needed to save the results into a text file using the ScopeView export button  and selecting a file (WindTurbineScan.txt)

7.3 Combined scan

In this step the previously saved files GridScan.txt and WindTurbineScan.txt must be combined to obtain the waveforms in Figure 9. This can be done using ScopeView and summing the R and X values from each file.



Figure 9 Combined scan: WP impedance added to Grid impedance

To avoid risks of SSCI, the resistance value must be positive when the reactance crosses zero. In this example (Figure 9), the reactance crosses zero between 24Hz and 25Hz. For these frequencies, the combined resistance is negative which means that the system may become instable.

7.4 Time-domain verification

To verify the results from combined scan, a time-domain simulation of the event is performed (see Figure 3). The top line in this network is set to disconnect at 2.1 s due to a fault and when the current crosses zero in each breaker. This perturbation creates a resonance condition as verified from the WP current shown in Figure 10. The resonance frequency near 24.5 Hz is verified in this figure.

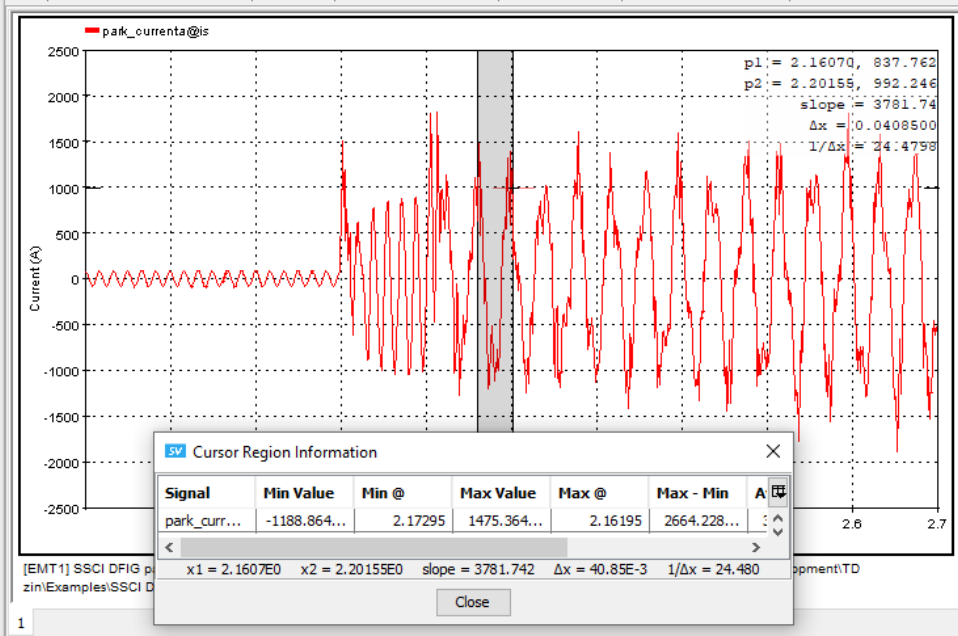

Figure 10 Time-domain verification of SSCI condition